

Maximum Power Point Tracking ML Series

ML4830 & ML4830-LI & ML2440 & ML2440-LI
Solar Charge and Discharge Controller

User Manual



Model	ML4830/ML4830-LI	ML2440/ML2440-LI
Battery Voltage	12V/24V/36V/48V	12V/24V
Max Solar Input Voltage	150V	150V
Charging Current	30A	40A
Discharging Current	20A	20A

Note: ML4830-LI and ML2440-LI can be used for lithium battery charging and discharging management.

Dear user:

Thank you for choosing our product !

Safety Instructions

1. Since the adaptable voltage of the solar charge controller exceeds human safety voltage, you are advised to read instructions before operation and operate the solar charge controller after completing safe operation training.
2. There are no parts that need maintaining or repairing inside the solar charge controller. Users shall not disassemble or repair the controller by themselves.
3. Please install the solar charge controller indoors, avoid exposure of components, and prevent water from entering the controller.
4. Please install the solar charge controller in a well-ventilated place, for the temperature of the cooling fin can be very high during operation.
5. You are recommended to install appropriate insurance or circuit breaker outside the solar charge controller.
6. Before installing or adjusting the connecting wire of the solar charge controller, make sure that the photovoltaic array wire and insurance or circuit breaker near battery terminal are disconnected.
7. After installation, check whether all line connections are solid. Bad connections may cause hazards due to heat accumulation.

 **Warning:** indicates risky operation. Security preparation is required before operation.

 **Note:** indicates destructive operation.

 **Tip:** indicates advice and tips for the operator.

Catalog

1. Product Introduction	03
1.1 Product Overview and Features	03
1.2 Product Features	04
1.3 Introduction of the Maximum Power Point Tracking Technology	04
1.4 Introduction of Charging Stages	06
2. Product Installation	07
2.1 Installation Precautions	07
2.2 Wiring Specifications	08
2.3 Installation and Wiring	08
3. Product Operation and Display	11
3.1 LED Indicator	11
3.2 Buzzer	12
3.3 Key Operation	12
3.4 LCD Starting and Main Interface Display	12
3.5 Load Mode Setting Page	15
3.6 System Analysis Page	16
3.7 System Log Page	17
3.8 Parameter Setting Interface	18
3.9 Production Information Page	19
4. Product Protection Function and System Maintenance	19
4.1 Protection Function Introduction	19
4.2 System Maintenance	20
4.3 Abnormality Display and Alarm	20
5. Product Specification Parameter	21
5.1 Electrical Parameter	21
5.2 Parameter Adjustment Range	22
6. Conversion Efficiency Curve	23
7. Product Size	24

1. Product Introduction

1.1 Product Overview and Features

The solar charge controller can monitor generated power of solar panels in real time and track the highest voltage current value (VI), enabling the system to charge the battery with maximum power output. Applied to solar off-grid photovoltaic systems, the product coordinates the functions of solar panels, batteries and loads; and is the core control unit of off-grid photovoltaic systems.

The controller uses liquid crystal for the dynamic display of operation status, operating parameters, controller logs, historical parameters, and control parameters. Users can check all parameters through buttons, and modify control parameters according to actual needs so that different system requirements are met.

The controller adopts standard Modbus communication protocol, making it easy for users to view and modify system parameters by themselves. We provide free monitoring software, which delivers the greatest possible convenience for users to satisfy different needs of remote monitoring.

The inside of the solar charge controller is equipped with comprehensive electronic fault self-detecting function and powerful electronic protection function, therefore avoiding damage to product components resulting from installation errors and system faults to the greatest extent.

Product Features

- ◆ Advanced double-peak or multiple-peak tracking technology. When the panel has a shadow block or a part of the panel is damaged, I-V curve shows multiple peaks. The solar charge controller can still accurately track the maximum power point.
- ◆ Built-in algorithm for maximum power tracking. This significantly raises energy utilization efficiency of photovoltaic systems, with charging efficiency 15% ~ 20% higher than traditional PWM solar charge controllers.
- ◆ Combination of multiple tracking algorithms that can track the optimum working point of I-V curve accurately in a very short period of time.
- ◆ MPPT tracking efficiency can be as high as 99.9%.
- ◆ Advanced digital power technology, with circuit energy conversion efficiency as high as 98%.
- ◆ Supporting charging procedures of gel batteries, sealed batteries, open batteries, lithium batteries and other types of batteries.①
- ◆ Current-limiting charging mode. When the power of a solar panel is too large, and the charging current is greater than rated current, the solar charge controller automatically reduces charging power, thereby making the solar panel work at rated charging current.
- ◆ Supporting the start of capacitive load instantaneous large current.
- ◆ Supporting automatic identification of battery voltage.
- ◆ LED indicator of malfunction, buzzer alarm, and liquid crystal display of abnormal information. This helps users identify system failures.
- ◆ Supporting historical data storage for up to 5 years.
- ◆ LCD screen display function. The display enables users to view equipment operation data and status, and modify controller parameters at the same time.
- ◆ Supporting standard Modbus protocol that meets communication needs on different occasions.
- ◆ Built-in mechanism of over-temperature protection. When the temperature exceeds the preset value, the charging current falls linearly with temperature, therefore slowing down the rise of controller temperature and avoiding controller damage from high temperature.
- ◆ External battery voltage sampling function. This function prevents line loss from affecting external battery voltage sampling and ensures greater preciseness of control parameters.
- ◆ Temperature compensation functions. Charging and discharging parameters are automatically adjusted, thereby extending battery service life.
- ◆ TVS lightning protection.

Note① : Only the ML-LI model supports lithium battery charging and discharging function.

1.2 Product Features

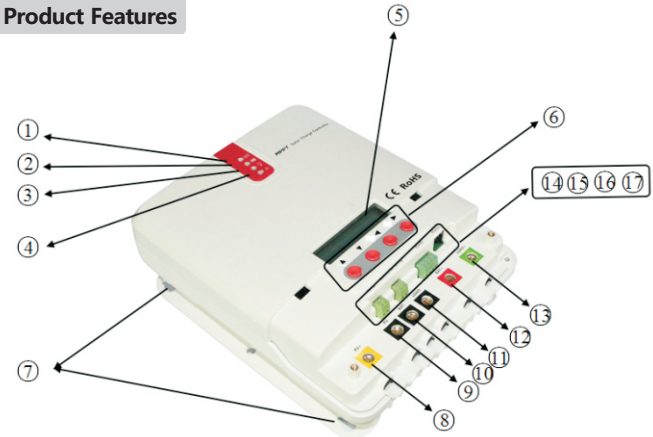

Figure 1-1 Solar Charge Controller Appearance and Interface

No.	Name	No.	Name
1	Charging Indicator	10	Battery "-" Interface
2	Battery Indicator	11	Load "-" Interface
3	Load Indicator	12	Battery "+" Interface
4	Abnormality Indicator	13	Load "+" Interface
5	Liquid Crystal Display	14	External Temperature Sampling Interface
6	Operation Button	15	External Battery Voltage Sampling Interface
7	Mounting Hole	16	RS485 Communication Interface
8	Solar Panel "+" Interface	17	RS232 Communication Interface
9	Solar Panel "-" Interface		

1.3 Introduction of the Maximum Power Point Tracking Technology

The Maximum Power Point Tracking (MPPT) system is an advanced charging technology that enables solar panels to output more power by adjusting the working state of electrical modules. Due to the nonlinearity of a solar array, there is a maximum energy output point (maximum power point) on the curve of the array. Traditional solar charge controllers (switch charging technology and PWM charging technology) cannot charge batteries at this point, thus unable to obtain the maximum energy of solar panels. However, the solar energy charge controller equipped with the MPPT control technology can track the maximum power point of a solar array at any time in order to gain maximum energy for battery charging.

Take the 12V system for example. The peak voltage of solar panels (V_{pp}) is around 17V and battery voltage is about 12V. Generally, when the solar charge controller is charging a battery, the voltage of solar panel is maintained at about 12V, indicating that the maximum power is not used. MPPT solar charge controllers provide a solution to that problem by constantly adjusting the input voltage and current of solar panels, therefore maximizing input power.

Compared with conventional PWM solar charge controllers, MPPT solar charge controllers bring out the maximum power of solar panels and provide greater charging current. Generally speaking, MPPT solar charge controllers can improve energy utilization rate by 15% ~ 20% over PWM solar charge controllers.

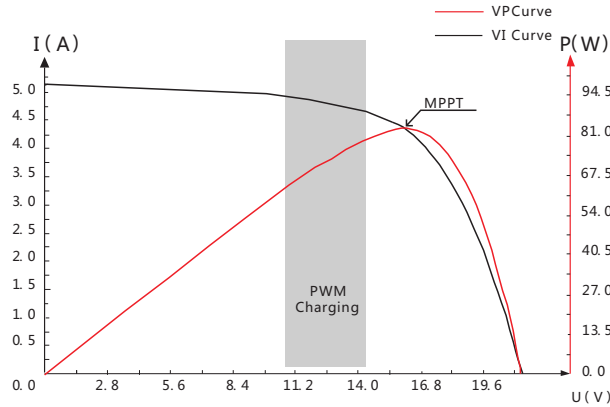

Figure 1-2 Solar Panel Output Characteristic Curve

Moreover, different environmental temperatures and light conditions lead to frequent changes of the maximum power point. Our MPPT solar charge controller can constantly adjust parameters according to different conditions so as to put the system near the maximum working point all the time. The whole process is completely automatic without any adjustment by users.

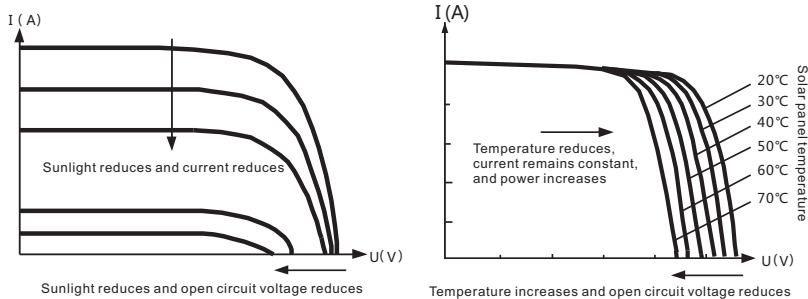

Figure 1-3 Solar Panel Output Characteristic and Lighting Relation

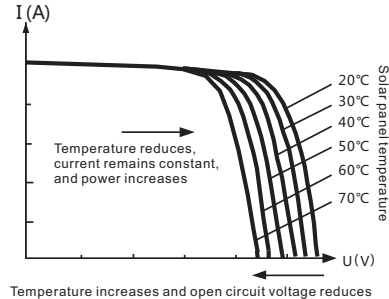

Figure 1-4 Solar Panel Output Characteristic and Temperature Relation

1.4 Introduction of Charging Stages

As a stage of charging, MPPT cannot be used separately, but must be combined with charging modes such as boost charging, floating charging and equalizing charging to complete battery charging together. A complete charging process includes: fast charging, maintaining charging and floating charging. The charging curve is as follows:

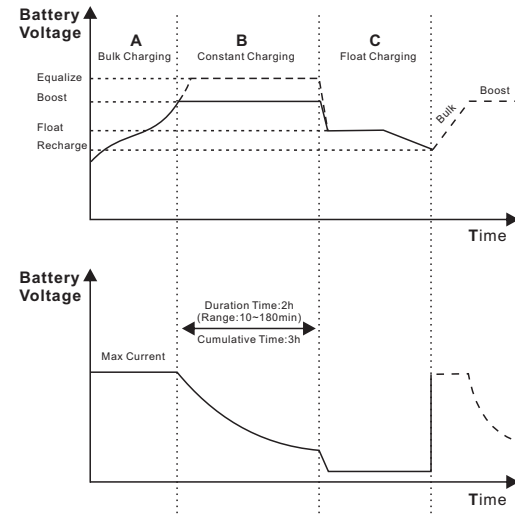

Figure 1-4 Battery Charging Stage

➤ Fast Charging

In fast charging stage, battery voltage is below the preset value (equalizing/boost voltage) of full voltage. The solar charge controller will perform MPPT charging and provide the maximum solar power to charge battery. After battery voltage reaches the preset value, the controller conducts constant-voltage charging.

➤ Maintaining Charging

When battery voltage reaches the preset value for maintaining voltage, the solar charge controller performs constant-voltage charging, and this process does not involve MPPT charging. At the same time, charging current declines gradually over time. There are two stages in maintaining charging, which are equalizing charging and boost charging. The two charging processes are not repeated processes. Equalizing charging is started once every 30 days in a month.

▶ Boost Charging

The boost charging stage generally lasts 2 hours by default. Customers can adjust the duration and preset value of boost voltage according to actual needs. When the duration times reaches the preset value, the system enters floating charging stage.

► Equalizing Charging

⚠ Warning: explosion!

Balance opening lead-acid batteries may produce explosive gas, and cabins of the batteries must be well ventilated.

⚠ Attention: equipment damage!

Balance can push up battery voltage to a level that may damage sensitive DC load. Verification is required to ensure that the allowed input voltage of all system loads is higher than the set value of equalizing charging for batteries.

⚠ Attention: equipment damage!

Overcharging or too much gas evolution may damage battery plates and cause active materials on battery plates to fall off. Damages may be caused if equalizing charging voltage is too high or equalizing charging lasts too long. You are advised to carefully read the specific requirements on batteries used in the system.

Some types of batteries benefit from regular equalizing charging, which can stir up electrolyte, equalizing battery voltage, and complete chemical reaction. Equalizing charging boosts battery voltage to a level higher than standard complement voltage, resulting in gasification of battery electrolyte. If it is detected that the solar charge controller automatically controls the next process to perform equalizing charging, equalizing charging duration will be 120 minutes (default). Equalizing charging and boost charging are not repeated in one full charge process. This is to avoid too much gas evolution or battery overheating.

⚠ Attention:

When the system cannot maintain battery voltage steadily at constant voltage due to installation environment or operation with load, the solar charge controller performs time accumulation until battery voltage reaches the preset value. After the cumulative time reaches three hours, the system automatically transfers to floating charging.

If the clock of the solar charge controller is not calibrated, the controller performs regular equalizing charging in accordance with its internal clock.

► Floating Charging

After a charging stage continues, the solar charge controller reduces battery voltage by decreasing the charging current, and maintains battery voltage at the preset voltage value for floating charging. At floating charging stage, the battery undergoes very weak charging to ensure that the battery is in full charge state. At floating charging stage, the load can obtain nearly all the solar power. If the load exceeds the power provided by solar energy, the solar charge controller fails to maintain battery voltage at floating stage. When battery voltage is as low as the preset value for improved recovery charging, the system exits from floating charging stage and re-enters fast charging stage.

2. Product Installation

2.1 Installation Precautions

- ◆ Exert great caution during battery installation. Before installing open lead-acid battery, wear protective goggles. When you are in contact with battery acid liquid, wash the involved part with water immediately.
- ◆ Do not place metal objects near battery to prevent short circuit.
- ◆ When battery is charging, acidic gas can be produced. Ensure that the environment around is well ventilated.
- ◆ Battery may generate combustible gas. Keep it away from sparks.
- ◆ For outdoor installation, avoid direct sunlight and rain infiltration.

- ◆ Loose connections and corrosive wires may cause extreme heat that melts wire insulation layers, burns surrounding materials, or even results in fire. Ensure that connection heads are screwed tight, and wires are better fixed with tightening belts. Avoid wire shaking and loose connection heads when moving the application.
- ◆ When the system is connected, the output terminal voltage of components can be higher than human safety voltage. During operation, use insulated tools and make sure your hands are dry.
- ◆ The battery terminals on the solar charge controller can be connected with one battery or the same set of batteries. Follow-up instructions in the manual apply to the use of single battery. The same instructions apply to a system with a set of batteries as well.
- ◆ Please follow battery manufacturers' safety recommendations.
- ◆ System connecting line is selected according to current density of no greater than 4A/mm².
- ◆ Connect the solar charge controller grounding terminal to the ground.

2.2 Wiring Specifications

Wiring and installation mode must comply with national and local electrical standard requirements. Battery and load specifications must be selected according to the rated current. Refer to the following table for wiring specifications:

Model	Rated Charging Current	Rated Discharging Current	Battery Wire Diameter	Load Line Diameter
ML4830	30A	20A	8 mm ²	5 mm ²
ML2440	40A	20A	10 mm ²	5 mm ²

2.3 Installation and Wiring

⚠ Warning: Explosion risk. Do not install the solar charge controller and open type cell in the same closed space. Do not install in closed place where battery gas may gather.

⚠ Warning: High pressure danger. Photovoltaic array may generate very high open circuit voltage. Before wire connection, disconnect the breaker or insurance. Be careful in the process of wiring.

⚠ Attention: When installing a solar charge controller, make sure there is enough air flowing through the cooling fin of the controller. Leave a space of at least 150 mm up and down the solar charge controller to ensure natural heat loss through convection. If installed within a closed cabinet, ensure reliable heat dissipation through the cabinet body.

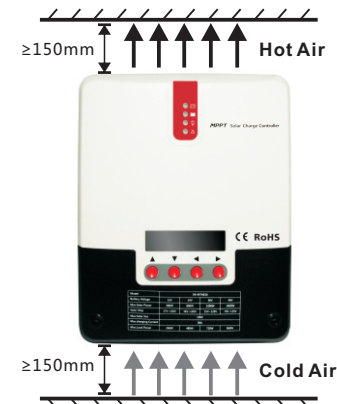

Figure 2-1 Installation and Heat Dissipation

Step 1: Selecting an installation location.

Avoid installing solar charge controller in a place where there is direct sunlight, high temperature or easy water inflow. Ensure the surrounding area of the solar charge controller is well ventilated.

Step 2:

First place installation guide plate at proper position, then use pen and mark on installation location, drill four installation holes at marked places of suitable size, and fix with screw.

Step 3: Fix the solar charge controller.

On the installation surface, use a pen to mark the positions of four mounting holes, and then move away solar charge controller. Drill four size-suitable mounting holes at four marked positions, and fix screws in advance, align fixing holes of solar charge controller to on the four fixed screws, and then hang it up.

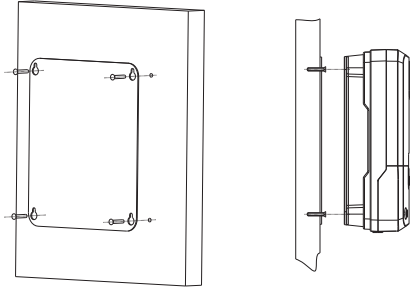

Figure 2-2 Fix the solar charge controller

Step 4: Wiring

Remove the two screws on the solar charge controller panel, and then start wiring. For installation security, we recommend the following wiring sequence. However, wiring without following this order will not damage the solar charge controller.

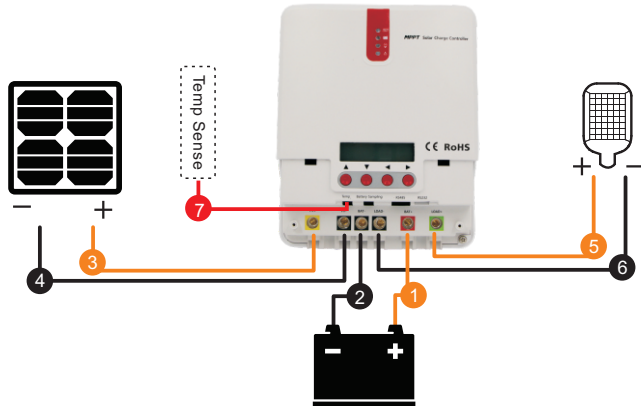





Figure 2-3 Wiring

- ① External temperature sampling interface connection
- ② Battery voltage sampling line connection
- ③ Communication cable connection
- ④ Connect power line

 Warning: Risk of electric shock! We strongly recommend access insurance or circuit breaker at photovoltaic array end, load end and battery end, to prevent electric shock from occurring during wiring or misoperation. Before wiring, ensure that insurance or circuit breaker is disconnected.

 Warning: High pressure danger! Photovoltaic array may generate very high open circuit voltage. Before wire connection, disconnect the breaker or insurance. Be careful in the process of wiring.

 Warning: Risk of explosion. Short circuit of battery positive and negative terminals and wires connected to them will cause fire or explosion. Please be careful during operation. Please connect battery first, then connect load, and finally connect the solar panel, please follow the connection mode of "+" first and then "-".

⑤ Power On

Tip: ML series solar charge controller only starts the solar charge controller via wiring at the battery end, but ML - LI can start the solar charge controller via power of PV array,. This applies to starting the solar charge controller and activating lithium battery when lithium battery BMS is in the protection state and cannot export electricity externally.

When all the power line connections are firm and reliable, recheck whether the wiring is correct, and whether positive and negative ends are connected reversely. After confirmation, connect battery fuse or circuit breaker, observe whether LED indicator is lit, and whether LCD screen displays content. If there is no display, disconnect the fuse or circuit breaker immediately and recheck whether the circuit connection is correct.

If battery is powered on normally, connect the solar panel. If solar charge controller charging indicators are on normally or flashing, start battery charging.

When battery and photovoltaic is well connected, then connect load fuse or circuit breaker. At this time, you can use manual mode to test whether the load On and Off is normal. See load working mode and operation.

 **Warning:** When the solar charge controller is under normal charging state, disconnecting battery connection will affect solar charge controller DC load. In a severe case, the load can be damaged.

 **Warning:** Within 10 minutes after solar charge controller charging stops, battery reverse polarity operation may damage internal components of the solar charge controller.

Attention:

- 1) Battery insurance installation site should be as close as possible to the battery end. Recommended installation distance shall be no more than 150 mm.
- 2) When solar charge controller is not connected to a remote temperature sensor, battery temperature is a fixed value of 25 °C.
- 3) If the inverter is connected in the system, please connect inverter directly with battery, and do not connect solar charge controller with the load end.

⑥ Close wiring cover

When all wirings of the system are well connected, close the wiring cover and screw screws tight.

3. Product Operation and Display

3.1 LED Indicator

	PV array Indicator	Indicate solar charge controller current charging mode
	BAT Indicator	Indicate battery current state.
	LOAD Indicator	Indicate load switch and state.
	ERROR Indicator	Indicate whether solar charge controller is currently normal working.

➤ PV array Indicator

NO.	Graph	Indication State	Charging State
①	BULK	Steady On	MPPT Charging
②	ACCEPTANCE	Slow Flash (On 1s, Off 1s, cycle 2s)	Boost Charging
③	FLOAT	Single Flash (On 0.1s, Off 1.9s, cycle 2s)	Floating Charging
④	EQUALIZE	Fast Flash (On 0.1s, Off 0.1s, cycle 0.2s)	Equalizing Charging
⑤	CURRENT-LIMITED	Double Flash (On 0.1s, Off 0.1s, On 0.1s, Off 1.7s, cycle 2s)	Current Limited Charging
⑥		Off	Night

➤ BAT Indicator

Indication State	Battery State
Steady On	Battery Voltage Normal
Slow Flash (On 1s, Off 1s, cycle 2s)	Battery Over-Discharge
Fast Flash (On 0.1s, Off 0.1s, cycle 0.2s)	Battery Overvoltage

➤ LOAD Indicator

Indication State	Battery State
Off	Load Not Started
Fast Flash (On 0.1s, Off 0.1s, cycle 0.2s)	Overload/Short Circuit
Steady On	Load Normal Output

➤ ERROR Indicator

Indication State	Battery State
Off	System Operation No Abnormalities
Steady On	System Abnormal

3.2 Buzzer

After abnormality occurs, the buzzer sends out two short and a long buzzing sound.

Buzzer Buzzing State	Abnormality Type
Off	System no abnormalities or buzzing for 1 minute and then stop
Buzzing for 1 minute	Battery Over-Discharge, Under-Voltage, Load Short Circuit, Over-Load, Solar Controller Over-Temperature, and Battery Over-temperature
Buzzing for 15 seconds	Battery Under-Voltage
Constant Buzzing	Battery Overvoltage, PV Reverse Connection, PV Overvoltage

3.3 Key Operation

	Up	Menu page up; parameter decrease under setting mode
	Down	Menu page down; parameter increase under setting mode
	Return	Return to the previous menu
	Confirm	Enter submenu; Setting/Save key

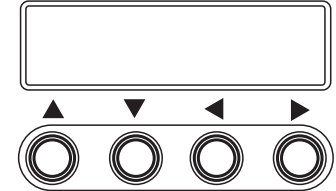

3.4 LCD Starting and Main Interface Display

➤ Starting Interface

S t a r t i n g . . .



M o d e l : S R - x x x x x x x



A U T O V O L T A G E
▶ 1 2 2 4 3 6 4 8

During start, the four indicators flash in flow. LCD starts after self-check. The model of the solar charge controller is displayed first, and then battery voltage level is displayed. Voltage level is displayed according to user-selected fixed voltage or voltage automatically identified.

➤ Main Page

Main page has 8 menus, in which menus with sub menus can press setting key to enter next menus

NO.	Page name	Page Note	Sub-menu
①	Charging Page Display	Charging state information real-time display, which can display information of solar panel voltage, charging state, charging current, battery voltage, and charging power	
②	Discharging Load Information Display Page	Load state information real-time display, which can display information of battery voltage, load switch state, discharging current, environment temperature, and discharging power	
③	Load Mode Setting Page	Load work mode adjustment page	Yes
④	Manual switch load page	The page is available only when load mode is manual mode 15, not displayed in other modes. In this page, load can be turned on and off from keys directly.	
⑤	System Analysis Page	System analysis page can view charging AH, discharging AH, work days, and system abnormality information	Yes
⑥	System Log Page	Log page can view solar controller historical information up to 5 years at most, including daily min battery voltage, battery max voltage, daily charging AH, and daily discharging AH, and etc	Yes
⑦	Parameter Setting Page	Parameter settings page can set some parameters of solar controller, including charging voltage, discharging voltage, temperature compensation coefficient, communication baud rate, and etc	Yes
⑧	Product Information	Product information can view solar controller serial number and version information	Yes

① Charging Page Display

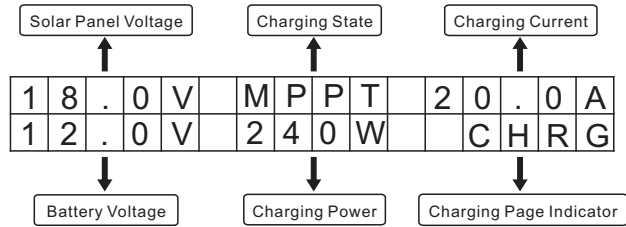

② Discharging Display Page

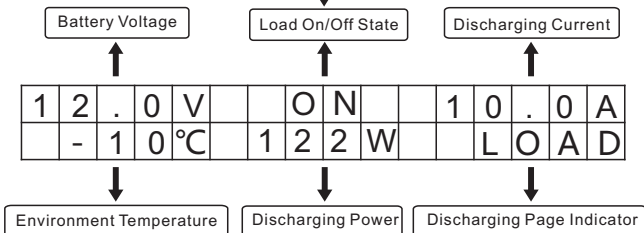

③ Load Mode Setting Page

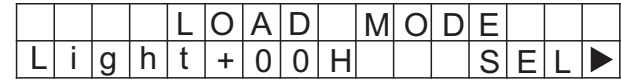

④ Switch load page

(can be seen when load mode is manual mode 15)



⑤ System Analysis Page

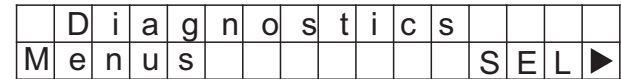

⑥ System Log Page



⑦ Parameter Setting Page

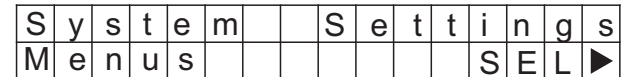

⑧ Product Information

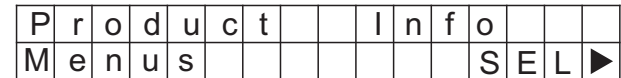

3.5 Load Mode Setting Page

➤ Load Mode Introduction

The solar controller has five load work modes, with modes referred as follows :

Code	Mode	Description
0	Pure light control (light on at night, off during daytime)	When there is no sunlight, the solar panel voltage is below the light control ON voltage, solar charge controller will open load after delay for a certain time, when the sunlight appears, solar panel voltage is above light control OFF voltage, solar charge controller will shut down the load after delay for a certain time
1~14	Light time control for 1~14 hours	When there is no sunlight, the solar panel voltage is below the light control ON voltage, solar charge controller will open load after delay for a certain time, load will shut down after working time reaches set value.
15	Manual Mode	Under this mode, the user can control load On and Off through keys, regardless of daytime or night. This mode is used in some special load situations or used for debugging.
16	Debugging Mode	Used for system debugging, close the load when there is light signal, open load when there is no light signal, convenient for checking the correctness of the system installation during installation and debugging.
17	Normal Open Mode	Power-on load has always maintained output state. This mode is suitable for load needing 24 hours power supply.

➤ Load Mode Adjustment

The user adjusts load mode according to needs. The debugging mode is set by default (see Load Mode Introduction). Mode adjustment method goes as follows:

Step ① Enter Load Mode Page

				L	O	A	D		M	O	D	E				
				L	i	g	h	t	+	1	6		S	E	L	▶

Step ② Short press the setting key to enter mode adjustment interface

				S	E	T		L	O	A	D		M	O	D	E		
				L	i	g	h	t	+	1	6		S	E	L	▶		

Step ③ Long press the setting key for 3 seconds Load mode will flash at this time

				S	E	T		L	O	A	D		M	O	D	E		
				L	i	g	h	t	+	1	6		S	E	L	▶		

Step ④ Press the +/- key to set needed load mode

				S	E	T		L	O	A	D		M	O	D	E		
				L	i	g	h	t	+	1	7		S	E	L	▶		

Step ⑤ Long press setting key to save and exit Setting is successful

				S	E	T		L	O	A	D		M	O	D	E		
				L	i	g	h	t	+	1	7		S	E	L	▶		

➤ Manual Switch Load Page

The page is available only when load mode is manual mode 15. When load in under manual mode, load can be turned on and off from following pages manually

Long press the setting key for 2 seconds to turn load on, page displays as follows:

				T	u	r	n		L	o	a	d		O	N			
				(H	o	l	d	▶	2		s	e	c)			

Long press the setting key for 2 seconds to turn load off, page displays as follows:

				T	u	r	n		L	o	a	d		O	F	F		
				(H	o	l	d	▶	2		s	e	c)			

3.6 System Analysis Page

In system analysis page, the user can use charging AH, discharging AH, work days, and system abnormality information, convenient for user to know the working condition of the whole system.

				D	i	a	g	n	o	s	t	i	c	s				
				M	e	n	u	s							S	E	L	▶

In this page, press setting key to enter system analysis sub menu page, with page contents as following table 3-6

No.	Displaying Items	Notes	Unit
1	Total Charge WH	Total Charge WH	KWH (度)
2	Total Charge AH	Total Charge AH	KAH
3	Total Dischg WH	Total Dischg WH	KWH (度)
4	Total Dischg AH	Total Dischg AH	KAH
5	Total Work Days	Total Work Days	Days
6	Total LVD Times	Total LVD Times	Times
7	Total FUL Times	Total FUL Times	Times
8	Error Code	Error Code	
	Controller temp	Controller temp	°C

Table 3-6

3.7 System Log Page

Log View of Current Day

Some system operation information record can be viewed at system log page, can view data records of five years at most, see Table 3-7 for information contents

```

  L o g g e d       D a t a
M e n u s         S E L ▶
  
```

In this page, press setting key to enter system log sub menu page, which is current day's log data by default, with page contents as following table 3-7

No.	Log Contents	Unit
1	Battery current day min voltage	V
2	Battery current day max voltage	V
3	Current day max charging current	A
4	Current day max discharging current	A
5	Current day max charging power	W
6	Current day max discharging power	W
7	Current day charging AH	AH
8	Current day discharging AH	AH
9	Current day generating capacity	KWH
10	Current day discharging capacity	KWH

Table 3-7

Log View of Different Days

To view log data of n days ago, the user needs to set a specified date. The setting is as follows:

Step ① : Long press setting key for 3 seconds in current log parameter

```

  D A Y :   0 0 0   B A T T E R Y
  2 2 . 0 V   M i n   S E L ▶
  
```

Days value start to flash at this time,
000 refers current days

```

  D A Y :   0 0 0   B A T T E R Y
  2 2 . 0 V   M i n   S E L ▶
  
```

Step ② : Press the +/- key to set the number of days
001 refers to value of previous day

```

  D A Y :   0 0 1   B A T T E R Y
  2 2 . 0 V   M i n   S E L ▶
  
```

Step ③ : Long press the setting key for 3 seconds, and save current days
At this time, press +/- key again to view other log contents of set days

```

  D A Y :   0 0 1   B A T T E R Y
  2 6 . 0 V   M a x   S E L ▶
  
```

3.8 Parameter Setting Interface

Under this menu, the user can view and set system parameters. Setting shall be performed under guidance of professional personnel; otherwise, setting error may cause system problems. See table 3-8 For parameter setting contents

Parameter Setting Contrast Table				
No.	Displaying Items	Notes	Parameter Scope	Default Parameters
1	TYPE OF BAT	Battery Type	User/flooded/Sealed/Gel	Sealed
2	CAP OF BAT	Battery Capacity	100~3000AH	200AH
3	VOLT OF SYS	System Voltage	12V/24V/36V/48V/AUTO	AUTO
4	OVR VOL DISC	Overvoltage Voltage	9.0~17.0V	16.0V
5	CHG LMT VOL	Charging Limit Voltage	9.0~17.0V	15.5V
6	EQUALIZ CHG	Equalizing charging Voltage	9.0~17.0V	15.2V
7	BOOST CHG	Boost charging Voltage	9.0~17.0V	14.4V
8	FLOAT CHG	Floating Charging Voltage	9.0~17.0V	13.8V
9	BOOST-RE CHG	Boost charging Recovery to Voltage	9.0~17.0V	12.6V
10	LOW VOL RECT	Over-Discharge Recovery	9.0~17.0V	12.6V
11	UND VOL WARN	Under-Voltage Warning	9.0~17.0V	12.0V
12	LOW VOL DISC	Over-Discharge Voltage	9.0~17.0V	11.0V
13	DISC LMT VOL	Over-Discharge Limit Voltage	9.0~17.0V	10.5V
14	LVD DELAY	Over-Discharge Delay Time	1~30s	5s
15	EQUALIZ TIME	Equalizing Charging Duration Time	0~600Min	120Min
16	BOOST TIME	Boost Charging Duration Time	10~600Min	120Min
17	AUTO EQUALIZ	Equalizing Charging Interval	0~255D(0 refers to close equalizing charging function)	30D
18	T-COMP SLOPE	Temperature Compensation Coefficient	0~5(0 refers to close compensation function)	-3mV/°C/2V
19	L-CON-VOL	Light Control Voltage	4~40V	5V
20	L-CON-DELAY	Light Control Delay Time	1~60Min	5Min
21	BAUD RATE	Communication Baud Rate	1200-115200	9600
22	MODBUS ADDR	Modbus Address	1-250	1
23	RS232 ADDR	RS232 Address	1-65530	1
24	BACK-LIGHT	Back-Light Delay Time	Steady on/10-60Sec	10Sec
25	RESTORE DEFAVL	Restore Factory Default Setting		

Table3-8 (All parameters can be set and viewed under User)

3.9 Production Information Page

You can check the controller model, serial number, software and hardware version etc. to learn about the product. For detailed information, please see Table 3-9

System Information				
No.	Name	Item	Parameter Example	Example Note
1	Model	Model:	ML4830	Solar charge controller model
2	Serial Number	HW:	15100032	The 32nd set of October 2015
3	Hardware version	SW:	00.05.00	Hardware version V0.5.0
4	Software version	Serial:	00.03.00	Software version V0.3.0

Table 3-9

4. Product Protection Function and System Maintenance

4.1 Protection Function Introduction

➤ Waterproof Protection

Waterproofing Grade : IP32

➤ Input limit power protection

When solar panel power exceeds the rated power, the solar charge controller limits solar panel power within the scope of rated power to prevent damage of the controller by excessive current, The solar charge controller enters current limit charging.

➤ Battery Reverse connection protection

When storage system is connected reversely, the system does not work and does not burn out solar charge controller.

➤ Photovoltaic input terminal voltage too high

Photovoltaic array input voltage is too high, and solar charge controller will automatically cut off PV input.

➤ Photovoltaic input terminal Short circuit protection

After short circuit of photovoltaic array input terminal, the solar charge controller disconnects charging, and when short circuit condition is removed, charging will be automatically restored.

➤ PV input reverse connection protection

When polarity of photovoltaic array is connected reversely, the solar charge controller will not be damaged, and will continue normal operation after correcting wiring error.

Warning: During reverse connection, battery voltage together with component element voltage must be less than 150V.

➤ Load over-power protection

When load exceeds the rated power, delayed load over-power protection will be started according to actual circumstances.

➤ Load short circuit protection

Provide timely and fast protection for short circuit of load, and try to start load automatically after a certain delay. The maximum number per day is 5 times. When load short circuit occurs, the user can also remove load short circuit manually in system data analysis page exception code.

➤ Night reverse connection proof protection

At night, prevent battery discharging via solar panel.

➤ TVS Lightning Protection

➤ Over-Temperature Protection

With temperature higher than the set temperature, the solar charge controller reduces charging power or stops charging. See the following figure

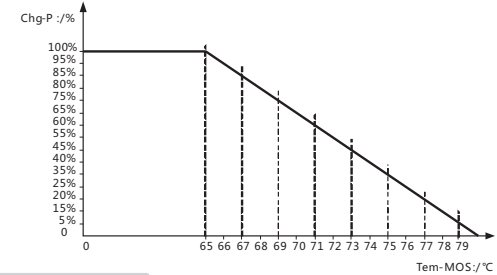

4.2 System Maintenance

- ◆ To maintain the best and long-term performance, it is recommended that following items are checked each year.
- ◆ Confirm that air flow around the solar charge controller is not blocked. Remove any dirt or debris on the cooling fin.
- ◆ Check whether insulation of bare wires is damaged due to sunburn, friction with other objects around, dry rot, insects or rodents destruction. Check whether repairing or wire replacement is necessary.
- ◆ Verify that indicators are consistent with equipment operation. Please pay attention to any fault or error displays, and take corrective actions when necessary.
- ◆ Check all wiring terminals to see if there is corrosion, insulation damage, high temperature or burning /discoloration signs, and tighten screw terminal.
- ◆ Check whether there are dirt, nest-building insects and corrosion phenomenon, and clean by following requirements.
- ◆ If lightning arrester has failed, timely replace invalid lightning arrester to prevent causing lightning damage to solar charge controller or even user's other equipments.



Warning: Risk of electric shock! In process of above operation, make sure all power supply of the solar charge controller has been disconnected, and then conduct related check or actions accordingly!

4.3 Abnormality Display and Alarm

No.	Error Display	Remarks	LED Indication	Buzzer Alarm
1	PV REV	Photovoltaic Modules Inversed Connection	ERROR indicator steady on	Buzzer keeps alarming
2	PV OVP	Photovoltaic Modules Overvoltage	ERROR indicator steady on	Buzzer keeps alarming
3	PV_MPP_OVP	Over Set Vmp Voltage	ERROR indicator steady on	Buzzer Alarm for 1Min
4	PV OVER CRT	Photovoltaic Modules Overload	ERROR indicator steady on	Buzzer Alarm for 1Min
5	OVER VOLTAGE	System Overvoltage	BAT Indicator fast flash ERROR indicator steady on	Buzzer keeps alarming
6	LOAD SHORT CRT	Load Short Circuit	LOAD Indicator fast flash ERROR indicator steady on	Buzzer Alarm for 1Min
7	LOAD OVER CRT	Overload	LOAD Indicator fast flash ERROR indicator steady on	Buzzer Alarm for 1Min
9	OVER TMP BAT	Environment Temperature Over-Temperature	ERROR indicator steady on	Buzzer Alarm for 1Min
11	OVER TMP MOS	Solar Charge Controller Internal Over-Temperature	ERROR indicator steady on	Buzzer Alarm for 1Min
12	OVER DISCHARGE	Battery Over-Discharge	BAT Indicator slow flash ERROR indicator steady on	Buzzer Alarm for 1Min
13	BAT UND VOL WARN	Battery Under-Voltage	ERROR indicator steady on	Buzzer Alarm for 15 seconds

5. Product Specification Parameter

5.1 Electrical Parameter

Parameter Name	Parameter Value	
Model	ML2440/ML2440-LI	ML4830/ML4830-LI
System Voltage	12V/24V Auto	12V/24V/36V/48V Auto
No-Load Loss	0.7 W ~ 1.2W	
Battery Voltage	9 ~ 35	9 ~ 70
Max Solar Energy Input Voltage	<150V	
Max Power Point Voltage Scope	Battery Voltage +2V ~ 120V	
Rated Charging Current	40A	30A
Rated Load Current	20A	
Max capacitive load capacity	10000uF	
PV System Max Input Power	520W/12V 1040W/24V	400W/12V 800W/24V 1200W/36V 1600W/48V
Conversion Efficiency	≤98%	
MPPT Tracking Efficiency	>99%	
Temperature compensation coefficient	-3mv/°C/2V (Default)	
Working Temperature	-35°C ~ +45°C	
Protection Level	IP32	
Weight	2.3Kg	
Max Wiring Size	25 mm ²	
Communication Mode	RS485, RS232	
Altitude	≤ 3000m	
Product Size	226*182*81mm	

5.2 Parameter Adjustment Range

Comparison Table of Parameters for Each Type of Battery				
Setting Voltage Battery Type	Sealed Lead-Acid Battery	Gelled Lead-Acid Battery	Open Lead-Acid Battery	User (User-Defined)
Overvoltage Disconnect Voltage	16.0V	16.0V	16.0V	9 ~ 17V
Equalizing Voltage	14.6V	—	14.8V	9 ~ 17V
Boost Voltage	14.4V	14.2V	14.6V	9 ~ 17V
Floating Voltage	13.8V	13.8V	13.8V	9 ~ 17V
Boost Restoring Voltage	13.2V	13.2V	13.2V	9 ~ 17V
Low Voltage Disconnect Restoring Voltage	12.6V	12.6V	12.6V	9 ~ 17V
Under-Voltage Alarming Restoring Voltage	12.2V	12.2V	12.2V	9 ~ 17V
Under-Voltage Alarming Voltage	12.0V	12.0V	12.0V	9 ~ 17V
Low Voltage Disconnect Voltage	11.1V	11.1V	11.1V	9 ~ 17V
Discharging Limit Voltage	10.6V	10.6V	10.6V	9 ~ 17V
Over-Discharge Delay Time	5s	5s	5s	1 ~ 30s
Equalizing Duration Time	120Min	—	120Min	0 ~ 600Min
Equalizing Charging Interval	30Days	0Day	30Days	0 ~ 250D (0 refers to close equalizing charging function)
Boost Duration Time	120Min	120Min	120Min	10 ~ 600Min

The User battery is customized battery. The system's default voltage parameters are consistent with sealed lead-acid battery parameters. When modifying battery charging and discharging parameters, observe the following logic:

- ◆ Overvoltage Disconnect Voltage > Charging Limit Voltage ≥ Equalizing Voltage ≥ Boost Voltage ≥ Floating Charging Voltage > Boost Restoring Voltage ;
- ◆ Overvoltage Disconnect Voltage > Overvoltage Disconnect Restoring Voltage ;
- ◆ Low Voltage Disconnect Restoring Voltage > Low Voltage Disconnect Voltage ≥ Discharging Limit Voltage ;
- ◆ Under-Voltage Alarming Restoring Voltage > Under-Voltage Alarming Voltage ≥ Discharging Limit Voltage ;
- ◆ Boost Restoring Voltage > Low Voltage Disconnect Restoring Voltage ;

6. Conversion Efficiency Curve

6.1 12V System Conversion Efficiency

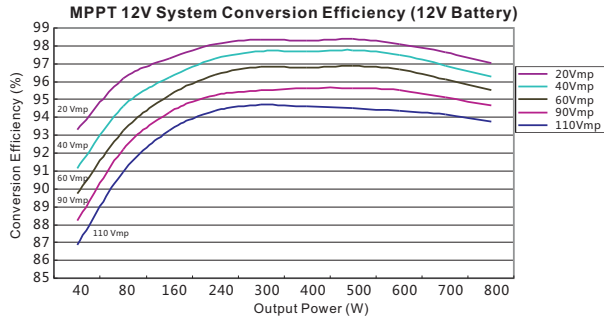

6.2 24V System Conversion Efficiency

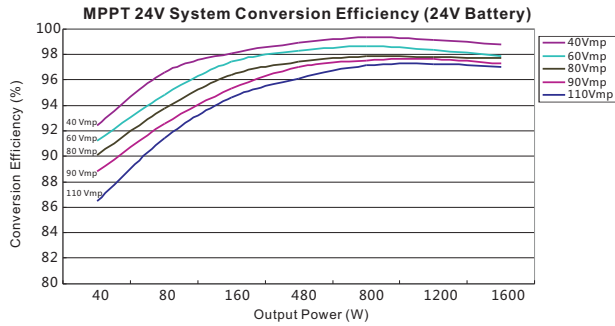

6.3 48V System Conversion Efficiency

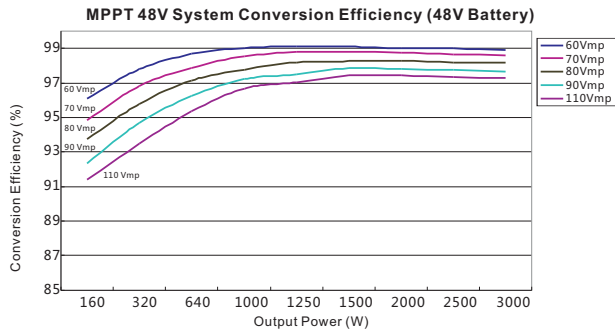

7. Product Size

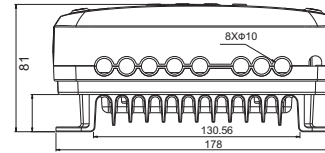
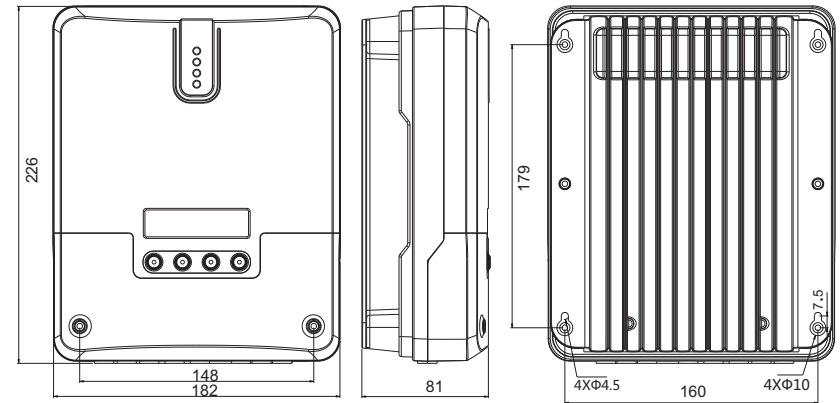

Technical requirements:
 Product size: 266*182*81mm
 Hole position: 179*160mm
 Hole size: Φ4.5mm
 Line material used: diameter <10mm